

# 8" Single Station

HIGH QUALITY WITHOUT THE HIGH PRICE!

## PWS-8110



Experience the **PWS-8110** and unleash superior clamping power at a fraction of the cost!

The **PWS-8110** features an innovative angled slide and locking jaw design that minimizes jaw lift, guaranteeing **repeatability** for **accurate** clamping every time.

## FEATURES:

**Jaw Width:** 8 inches

**Max Jaw Opening:** 11 inches

**Clamping Force:** Up to 12,000 lbs

**Clamping Repeatability:** Within 0.001"

**Bed Height:** 3.310"  $\pm$  0.0005"

- ✓ Hardened vise bed and jaw plates, ensuring long-lasting performance & resistance to wear
- ✓ 80,000 psi ductile iron body for maximum rigidity
- ✓ Sealed and lubricated thrust bearing for maximum life and minimum torque
- ✓ Outside rails of the vise body are machined within 0.0005" (0.013mm) square to jaw
- ✓ Footprint and keyway-to-jaw distance adheres to industry standard, ensuring compatibility



Contact us today for more information!

(855) 499-6454 | [www.TE-CO.com](http://www.TE-CO.com)

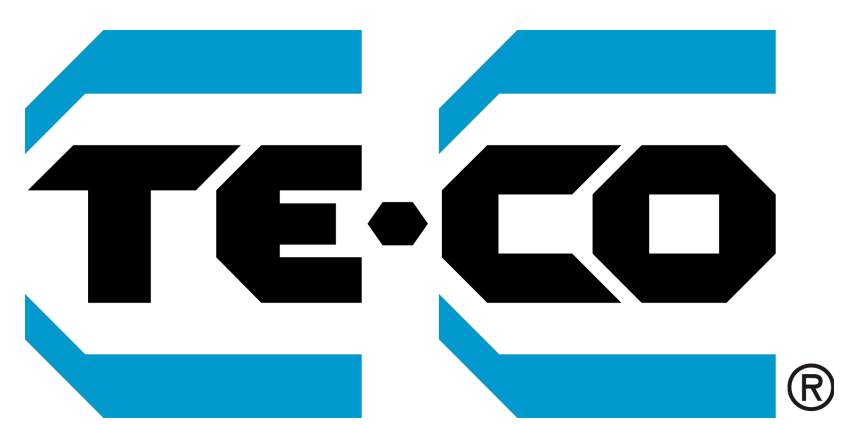

# Specifications

## 8" SINGLE STATION VISE PWS-8110 SPECIFICATIONS

### TOP VIEW

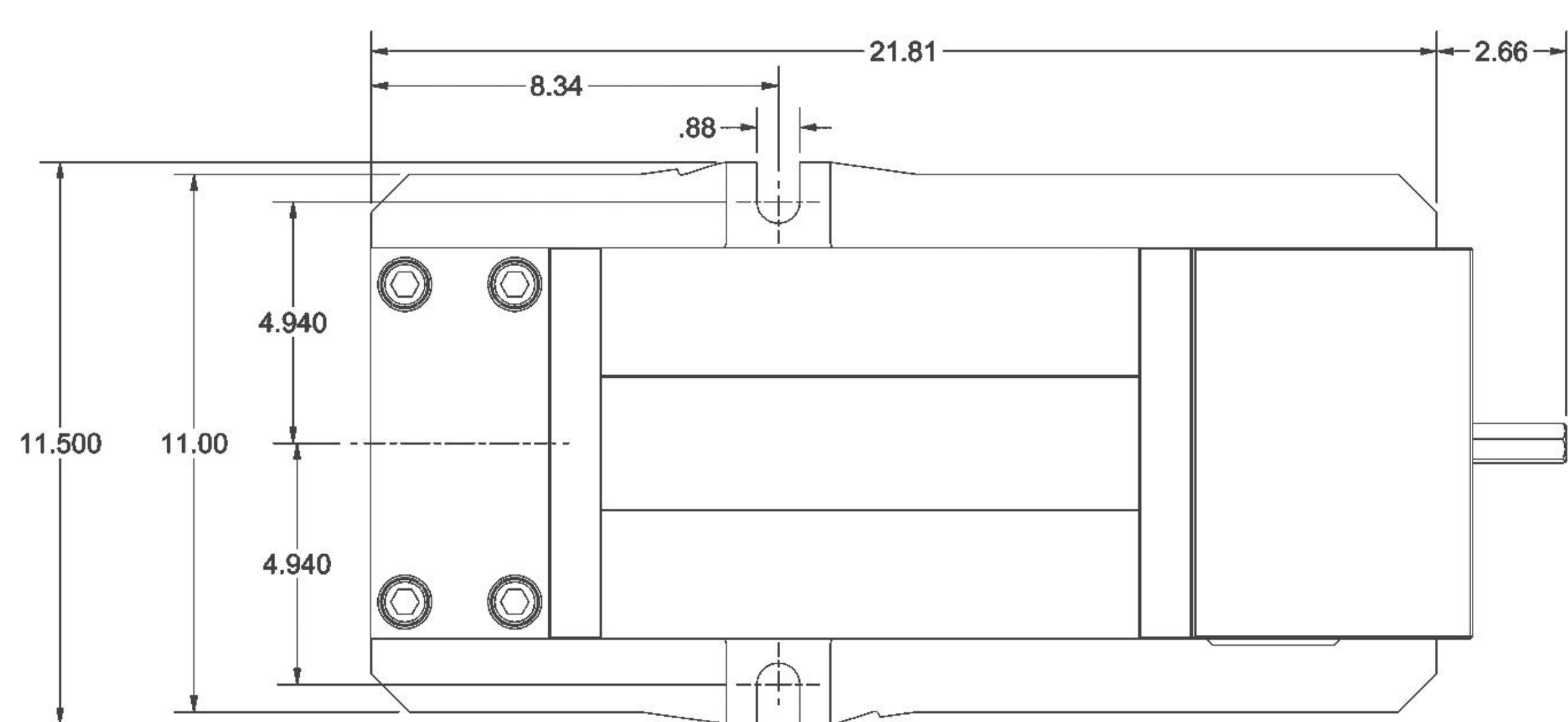

### JAW PLATE POSITION

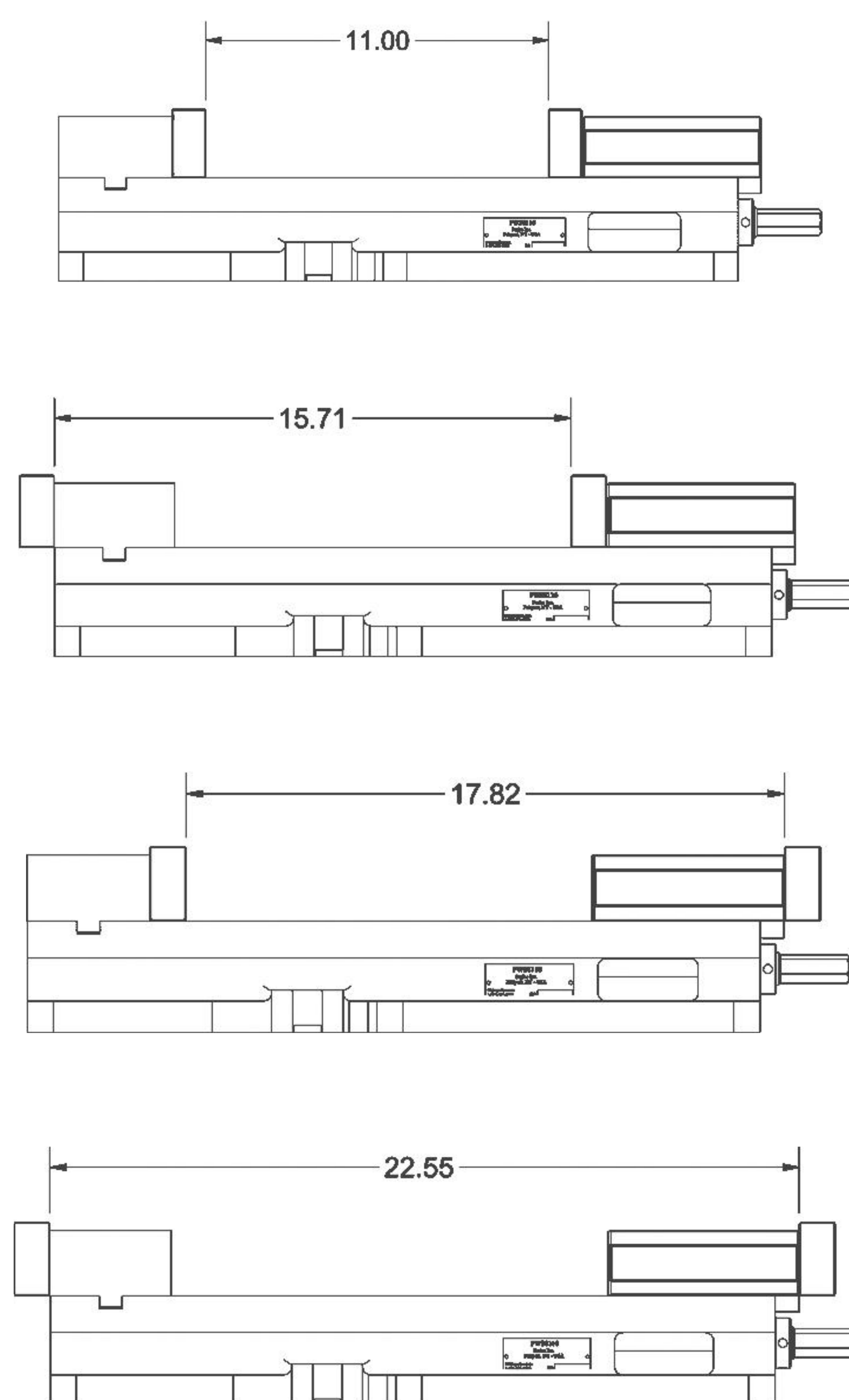

### SIDE VIEW

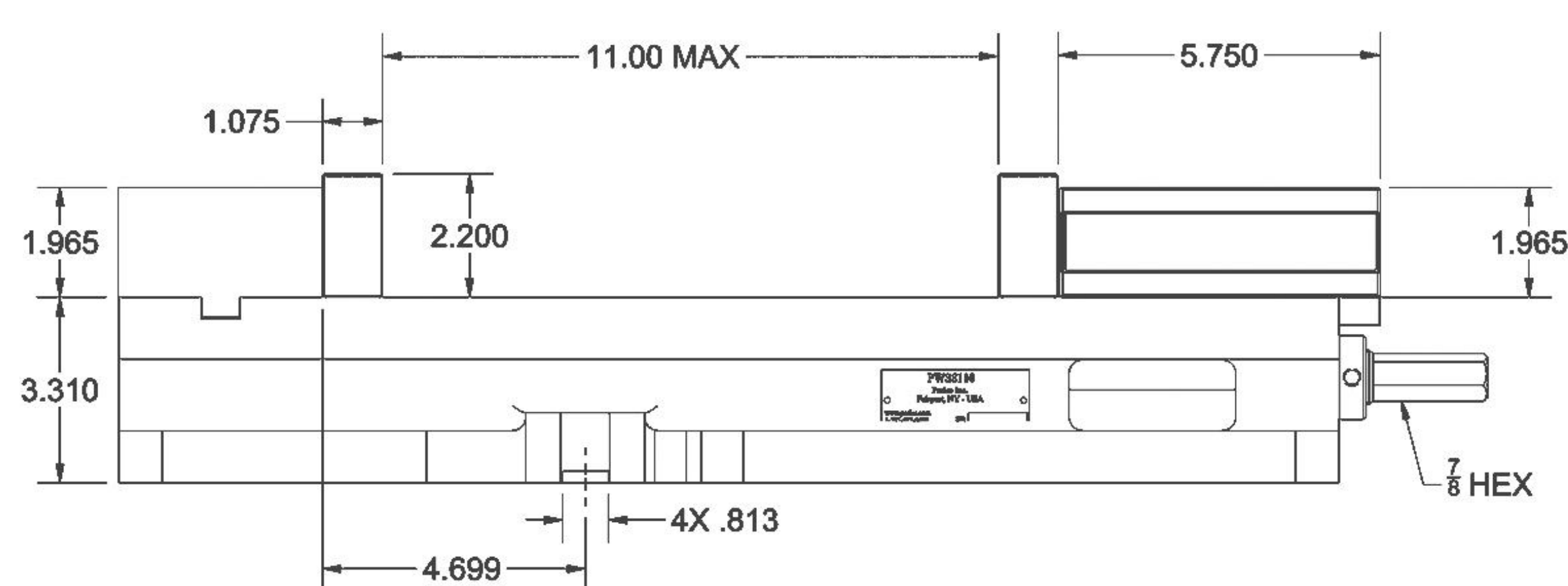

### FRONT VIEW

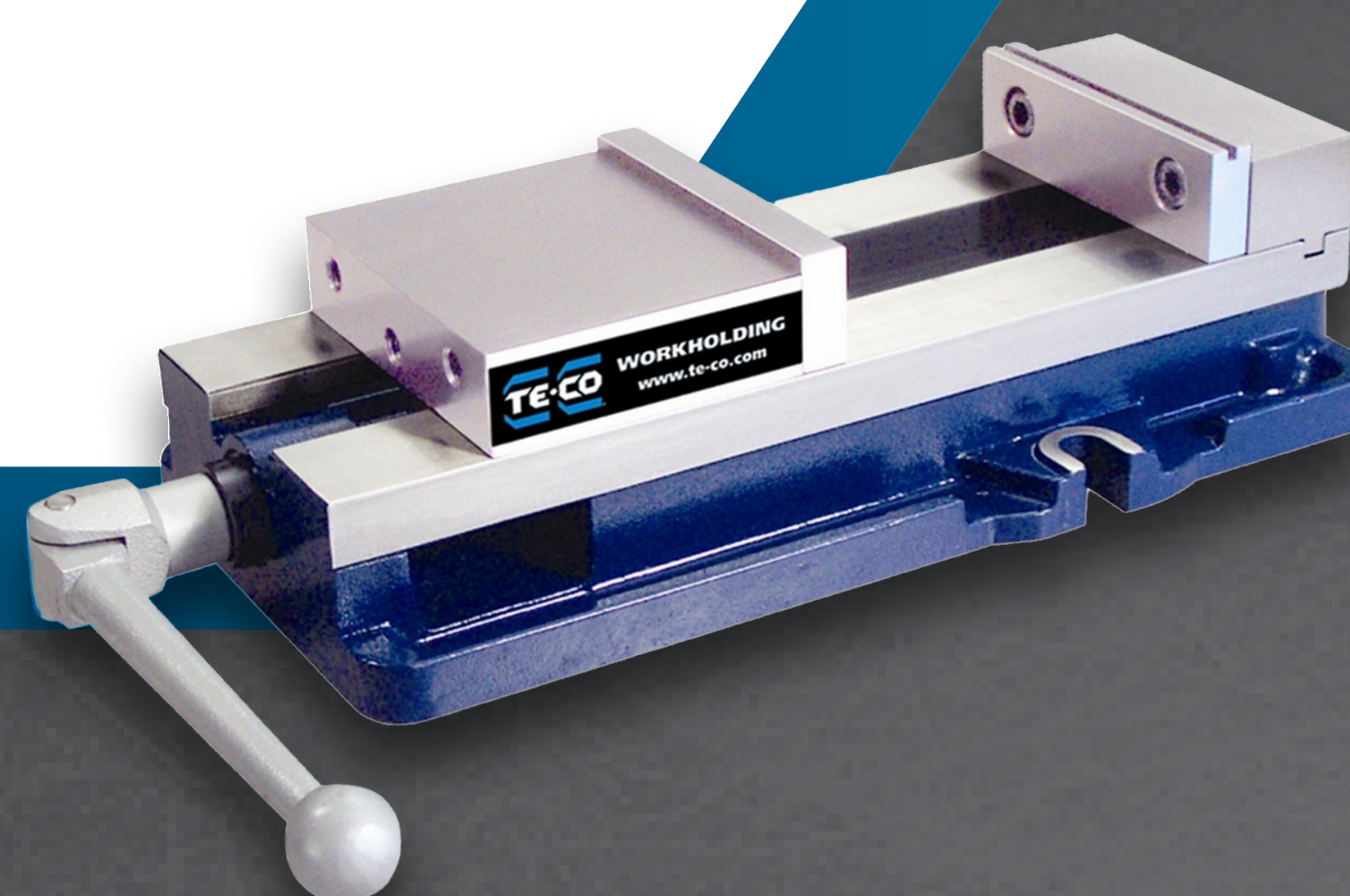
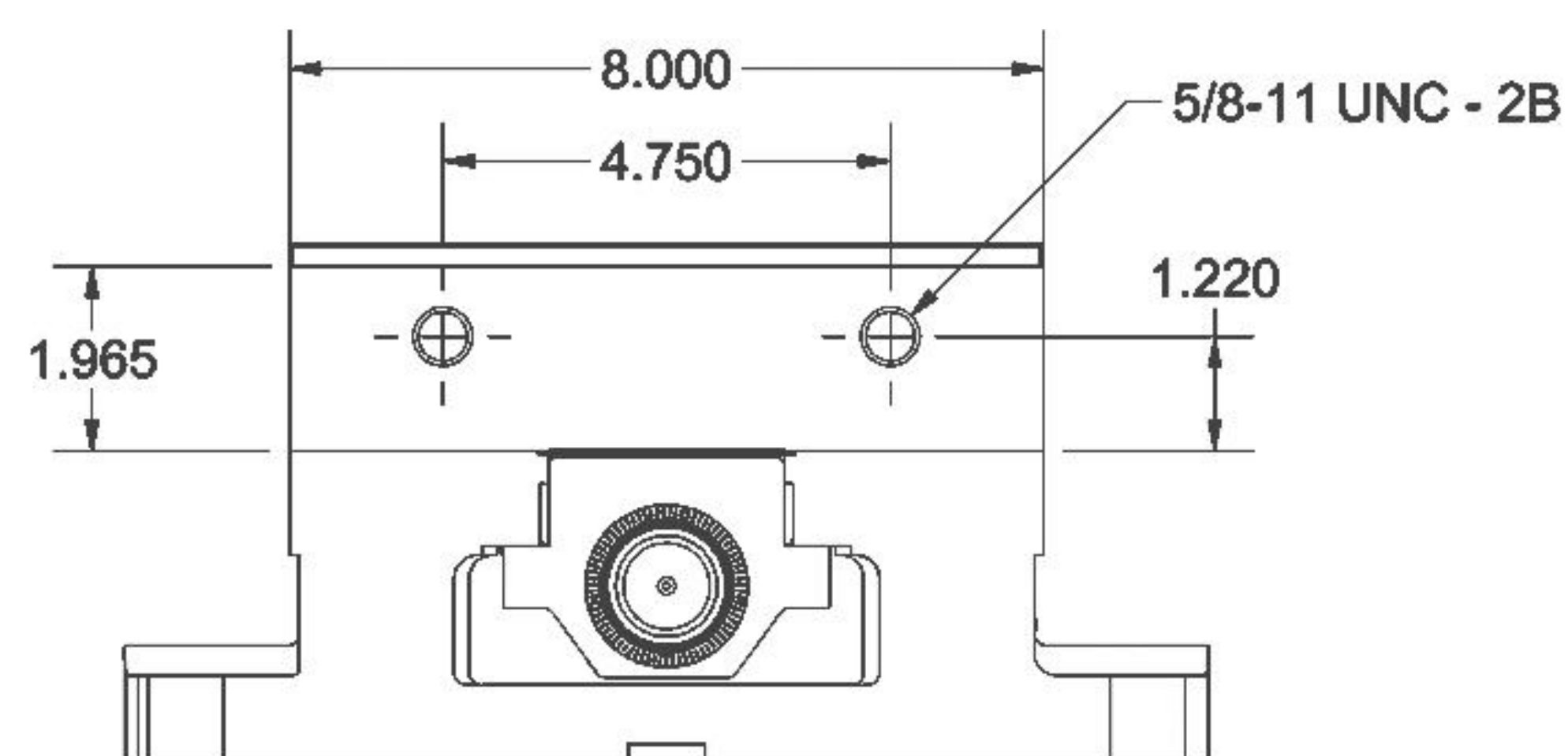

Learn more about  
the **PWS-8110**



Contact us today for more information!

(855) 499-6454 | [www.TE-CO.com](http://www.TE-CO.com)